













ÖVRIGA MATERIAL

MÄSSING

	M6SH	150
	MCS	150
	MFS	151
	MKFS	152
	MHGS	152

	M6M	153
	ML6M	153
	MHM	153
	MLHM	154
	LM6M	154
	MVM	154

	ENSAT	155
	SPIRO SP	155







	RB	156
	RBS	156
	FRB	156
	FRB FN	156

	TKS	157
	TKS FN	158
	TFS	158
	TFS FN	159
	TKFS	160
	TKFS FN	161

ALUMINIUM

	M6SH	162
	M6M	162
	RB	162

POLYAMID

	MCS	163
	MFS	163
	MKFS	164
	MHGS	164
	M6M	165
	RB	165
	RBS	165

M6SH

Sexkantskruv, mässing
DIN 933 (ISO 4014/4017)

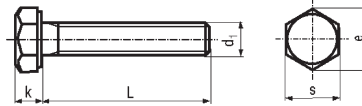

H = Helgängad
A = Anskaffning
Leveranstiden vid anskaffning
är normalt 1 - 6 veckor

<i>d</i>	M6	M8	M10	M12
Gängstigning	1	1,25	1,5	1,75
<i>k</i>	4	5,3	6,4	1,5
<i>s</i>	10	13	17(16)	19(18)

ART.NR.	DIMENSION	PRIS/100	FÖRP.	ART.NR.	DIMENSION	PRIS/100	FÖRP.
3111006008	M 6x8 H	493,00	100	3111010016	M 10x16 H	2 556,00	100
3111006010	M 6x10 H	551,00	100	3111010020	M 10x20 H	2 600,00	100
3111006012	M 6x12 H	580,00	100	3111010025	M 10x25 H	2 762,00	100
3111006016	M 6x16 H	650,00	100	3111010030	M 10x30 H	2 806,00	100
3111006020	M 6x20 H	754,00	100	3111010040	M 10x40 H	3 226,00	100
3111006025	M 6x25 H	841,00	100	3111010050	M 10x50 H	4 388,00	100
3111006030	M 6x30 H	885,00	100	3111010060	M 10x60 H	4 974,00	100
3111006040	M 6x40 H	1 189,00	100	3111010070	M 10x70 H	5 510,00	100
3111006050	M 6x50 H	1 421,00	100	3111010080	M 10x80 H	6 018,00	100
3111006060	M 6x60 H	1 581,00	100	3111012016	M 12x16 H	3 795,00	50
3111008010	M 8x10 H	1 363,00	100	3111012020	M 12x20 H	3 900,00	50
3111008012	M 8x12 H	1 365,00	100	3111012025	M 12x25 H	4 608,00	50
3111008016	M 8x16 H	1 370,00	100	3111012030	M 12x30 H	4 700,00	50
3111008020	M 8x20 H	1 385,00	100	3111012040	M 12x40 H	4 713,00	50
3111008025	M 8x25 H	1 699,00	100	3111012050	M 12x50 H	5 757,00	50
3111008030	M 8x30 H	1 766,00	100	3111012060	M 12x60 H	6 667,00	50
3111008040	M 8x40 H	2 161,00	100	3111012070	M 12x70 H	8 384,00	50
3111008050	M 8x50 H	2 393,00	100	3111012080	M 12x80 H	8 500,00	50
3111008060	M 8x60 H	3 118,00	100	3111012090	M 12x90 H	9 406,00	50
3111008070	M 8x70 H	3 200,00	100	3111012100	M 12x100 H	9 800,00	50

MCS

Maskinskriv med cylindrisk skalle
och mejselfår, mässing
DIN 84 (≈ISO1207)

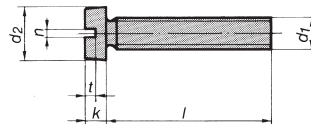

H = Helgängad
A = Anskaffning
Leveranstiden vid anskaffning
är normalt 1 - 6 veckor

<i>d1</i>	M3	M4	M5	M6
Gängstigning	0,5	0,7	0,8	1
<i>d2</i>	5,5	7	8,5	10
<i>k</i>	2	2,6	3,3	3,9
<i>n</i>	0,8	1,2	1,2	1,6
<i>t</i>	0,85	1,1	1,3	1,6

ART.NR.	DIMENSION	PRIS/100	FÖRP.	ART.NR.	DIMENSION	PRIS/100	FÖRP.
3700003005	M3X5 H	203,00	100	3700004010	M4X10 H	305,00	100
3700003006	M3X6 H	186,00	100	3700004012	M4X12 H	323,00	100
3700003008	M3X8 H	176,00	100	3700004016	M4X16 H	345,00	100
3700003010	M3X10 H	195,00	100	3700004020	M4X20 H	416,00	100
3700003012	M3X12 H	179,00	100	3700004025	M4X25 H	456,00	100
3700003016	M3X16 H	215,00	100	3700004030	M4X30 H	500,00	100
3700003020	M3X20 H	276,00	100	3700004035	M4X35 H	581,00	100
3700003025	M3X25 H	302,00	100	3700004040	M4X40 H	578,00	100
3700003030	M3X30 H	357,00	100	3700004050	M4X50 H	780,00	100
3700003035	M3X35 H	417,00	100	3700005006	M5X6 H	516,00	100
3700003040	M3X40 H	567,00	100	3700005008	M5X8 H	411,00	100
3700003050	M3X50 H	855,00	100	3700005010	M5X10 H	377,00	100
3700004005	M4X5 H	329,00	100	3700005012	M5X12 H	507,00	100
3700004006	M4X6 H	279,00	100	3700005016	M5X16 H	540,00	100
3700004008	M4X8 H	285,00	100	3700005020	M5X20 H	614,00	100

ART.NR.	DIMENSION	PRIS/100	FÖRP.	ART.NR.	DIMENSION	PRIS/100	FÖRP.
3700005025	M5X25 H	696,00	100	3700006012	M6X12 H	729,00	100
3700005030	M5X30 H	810,00	100	3700006016	M6X16 H	810,00	100
3700005035	M5X35 H	885,00	100	3700006020	M6X20 H	831,00	100
3700005040	M5X40 H	1 070,00	100	3700006025	M6X25 H	1 011,00	100
3700005050	M5X50 H	1 155,00	100	3700006030	M6X30 H	1 202,00	100
3700005060	M5X60 H	1 535,00	100	3700006040	M6X40 H	1 457,00	100
3700006008	M6X8 H	764,00	100	3700006050	M6X50 H	1 634,00	100
3700006010	M6X10 H	641,00	100	3700006060	M6X60 H	1 934,00	100

MFS

Maskinkrur med försänkt skalle
och mejselfår, mässing
DIN 963 (≈ISO 2009)

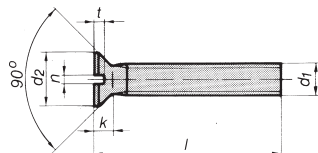

H = Helgängad
A = Anskaffning
Leveranstiden vid anskaffning
är normalt 1 - 6 veckor

<i>d1</i>	<i>M3</i>	<i>M4</i>	<i>M5</i>	<i>M6</i>
Gängstigning	0,5	0,7	0,8	1
<i>d2</i>	5,6	7,5	9,2	11
<i>k</i>	1,65	2,2	2,5	3
<i>n</i>	0,8	1	1,2	1,6
<i>t</i>	0,6	0,8	1	1,2

ART.NR.	DIMENSION	PRIS/100	FÖRP.	ART.NR.	DIMENSION	PRIS/100	FÖRP.
3701003006	M3X6H	200,00	100	3701005008	M5X8H	453,00	100
3701003008	M3X8H	203,00	100	3701005010	M5X10 H	461,00	100
3701003010	M3X10 H	212,00	100	3701005012	M5X12 H	477,00	100
3701003012	M3X12 H	224,00	100	3701005016	M5X16 H	545,00	100
3701003016	M3X16 H	254,00	100	3701005020	M5X20 H	591,00	100
3701003020	M3X20 H	291,00	100	3701005025	M5X25 H	668,00	100
3701003025	M3X25 H	326,00	100	3701005030	M5X30 H	774,00	100
3701003030	M3X30 H	401,00	100	3701005035	M5X35 H	998,00	100
3701003035	M3X35 H	422,00	100	3701005040	M5X40 H	1 044,00	100
3701003040	M3X40 H	597,00	100	3701005050	M5X50 H	1 205,00	100
3701004006	M4X6 H	272,00	100	3701005060	M5X60 H	1 535,00	100
3701004008	M4X8H	296,00	100	3701006010	M6X10 H	621,00	100
3701004010	M4X10 H	308,00	100	3701006012	M6X12 H	698,00	100
3701004012	M4X12 H	314,00	100	3701006016	M6X16 H	798,00	100
3701004016	M4X16 H	377,00	100	3701006020	M6X20 H	881,00	100
3701004020	M4X20 H	437,00	100	3701006025	M6X25 H	938,00	100
3701004025	M4X25 H	461,00	100	3701006030	M6X30 H	1 082,00	100
3701004030	M4X30 H	545,00	100	3701006035	M6X35 H	1 235,00	100
3701004035	M4X35 H	608,00	100	3701006040	M6X40 H	1 335,00	100
3701004040	M4X40 H	660,00	100	3701006050	M6X50 H	1 605,00	100
3701004050	M4X50 H	875,00	100	3701006060	M6X60 H	2 072,00	100

UTLÄMNING DIREKT FRÅN VÅRT LAGER

Bredvid vår butik ligger varuutlämningen där man kan hämta beställda varor.
Den har öppet mellan 07.00 - 17.00.

MKFS

Maskinskruv med kullerförsänkt skalle
och mejselspår, mässing
DIN 964 (≈ISO 2010)

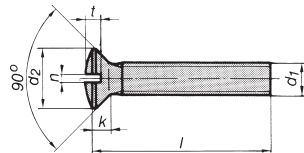

H = Helgängad
A = Anskaffning
Leveranstiden vid anskaffning
är normalt 1 - 6 veckor

<i>d1</i>	<i>M3</i>	<i>M4</i>	<i>M5</i>	<i>M6</i>
Gängstigning	0,5	0,7	0,8	1
<i>d2</i>	5,6	7,5	9,2	11
<i>k</i>	1,65	2,2	2,5	3
<i>n</i>	0,8	1	1,2	1,6
<i>t</i>	1,2	1,6	2	2,4

ART.NR.	DIMENSION	PRIS/100	FÖRP.	ART.NR.	DIMENSION	PRIS/100	FÖRP.
3702003008	M3X8 H	203,00	100	3702005012	M5X12 H	477,00	100
3702003010	M3X10 H	212,00	100	3702005016	M5X16 H	545,00	100
3702003012	M3X12 H	224,00	100	3702005020	M5X20 H	597,00	100
3702003016	M3X16 H	254,00	100	3702005025	M5X25 H	668,00	100
3702003020	M3X20 H	291,00	100	3702005030	M5X30 H	774,00	100
3702003025	M3X25 H	326,00	100	3702005035	M5X35 H	998,00	100
3702004006	M4X6 H	272,00	100	3702005040	M5X40 H	1 044,00	100
3702004008	M4X8 H	296,00	100	3702005050	M5X50 H	1 205,00	100
3702004010	M4X10 H	308,00	100	3702006012	M6X12 H	698,00	100
3702004012	M4X12 H	314,00	100	3702006016	M6X16 H	798,00	100
3702004016	M4X16 H	377,00	100	3702006020	M6X20 H	881,00	100
3702004020	M4X20 H	437,00	100	3702006025	M6X25 H	938,00	100
3702004025	M4X25 H	461,00	100	3702006030	M6X30 H	1 082,00	100
3702004030	M4X30 H	545,00	100	3702006035	M6X35 H	1 235,00	100
3702004035	M4X35 H	608,00	100	3702006040	M6X40 H	1 335,00	100
3702004040	M4X40 H	660,00	100	3702006050	M6X50 H	1 605,00	100
3702004050	M4X50 H	851,00	100	3702006060	M6X60 H	2 072,00	100
3702005010	M5X10 H	461,00	100				

MHGS

Helgängad stång, mässing
DIN 976

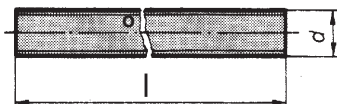

A = Anskaffning
Leveranstiden vid anskaffning
är normalt 1 - 6 veckor

<i>d</i>	<i>M2</i>	<i>M2,5</i>	<i>M3</i>	<i>M3,5</i>	<i>M4</i>	<i>M5</i>	<i>M6</i>	<i>M8</i>	<i>M10</i>	<i>M12</i>	<i>M16</i>	<i>M20</i>	<i>M22</i>	<i>M24</i>
Gängstigning	0,4	0,45	0,5	0,6	0,7	0,8	1	1,25	1,5	1,75	2	2,5	2,5	3

ART.NR.	DIMENSION	PRIS/100	FÖRP.	ART.NR.	DIMENSION	PRIS/100	FÖRP.
36050021000	M2X1000	24 300,00	1	36050081000	M8X1000	36 500,00	1
36050025100	M2,5X1000	11 300,00	1	36050101000	M10X1000	60 400,00	1
36050031000	M3X1000	10 400,00	1	36050121000	M12X1000	82 700,00	1
36050035100	M3,5X1000	17 800,00	1	36050161000	M16X1000	149 000,00	1
36050041000	M4X1000	13 100,00	1	36050201000	M20X1000	218 000,00	1
36050051000	M5X1000	20 000,00	1	36050241000	M24X1000	328 000,00	1
36050061000	M6X1000	21 800,00	1				

M6M

Sexkantmutter, mässing
DIN 934 (ISO 4032)

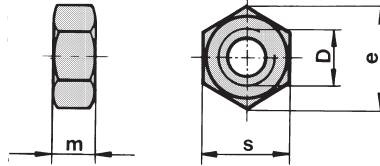

A = Anskaffning
Leveranstiden vid anskaffning
är normalt 1 - 6 veckor

d1	M2	M2,5	M3	M4	M5	M6	M8	M10	M12	M16	M20	M24
Gängstigning	0,4	0,45	0,5	0,7	0,8	1	1,25	1,5	1,75	2	2,5	3
s	4	5	5,5	7	8	10	13	17 (16)	19 (18)	24	30	36
m	1,6	2	2,4	3,2	4	5	6,5	8 (8,4)	10 (10,8)	13	16	19

ART.NR.	DIMENSION	PRIS/100	FÖRP.	ART.NR.	DIMENSION	PRIS/100	FÖRP.
33010020	M2	111,00	200	33010080	M8	483,00	100
33010025	M2,5	102,00	200	33010100	M10	1 430,00	100
33010030	M3	108,00	200	33010120	M12	2 038,00	100
33010040	M4	162,00	200	33010160	M16	3 704,00	100
33010050	M5	248,00	100	33010200	M20	4 598,00	25
33010060	M6	446,00	100	33010240	M24	12 179,00	25

ML6M

Låg sexkantmutter, mässing
DIN 439B

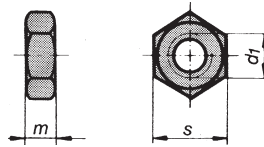

A = Anskaffning
Leveranstiden vid anskaffning
är normalt 1 - 6 veckor

d1	M3	M4	M5	M6	M8	M10	M12	M16	M20
Gängstigning	0,5	0,7	0,8	1	1,25	1,5	1,75	2	2,5
s	5,5	7	8	10	13	17	19	24	30
m	1,8	2,2	2,7	3,2	4	5	6	8	10

ART.NR.	DIMENSION	PRIS/100	FÖRP.	ART.NR.	DIMENSION	PRIS/100	FÖRP.
33065030	M3	105,00	200	33065100	M10	1 302,00	100
33065040	M4	192,00	100	33065120	M12	1 644,00	100
33065050	M5	158,00	100	33065160	M16	2 762,00	100
33065060	M6	267,00	100	33065200	M20	5 522,00	50
33065080	M8	473,00	100				

MHM

Hattmutter, mässing
DIN 1587 (≈SS 2180)

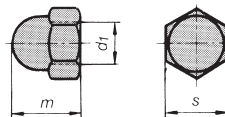

A = Anskaffning
Leveranstiden vid anskaffning
är normalt 1 - 6 veckor

d1	M3	M4	M5	M6	M8	M10	M12	M16
Gängstigning	0,5	0,7	0,8	1	1,25	1,5	1,75	2
s	5,5	7	8	10	13	17	19	24
m	6	8	10	12	15	18	22	28

ART.NR.	DIMENSION	PRIS/100	FÖRP.	ART.NR.	DIMENSION	PRIS/100	FÖRP.
33170030	M3	515,00	100	33170080	M8	1 800,00	100
33170040	M4	542,00	100	33170100	M10	2 300,00	100
33170050	M5	640,00	100	33170120	M12	3 200,00	100
33170060	M6	870,00	100	33170160	M16	6 100,00	50

MLHM

Låg hattmutter, mässing

DIN 917

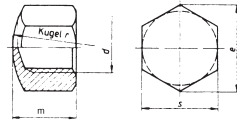

A = Anskaffning
Leveranstiden vid anskaffning
är normalt 1 - 6 veckor

<i>d1</i>	M4	M5	M6	M8
Gängstigning	0,7	0,8	1	1,25
<i>s</i>	7	8	10	13
<i>m</i>	5,5	7	9	12

ART.NR.	DIMENSION	PRIS/100	FÖRP.	ART.NR.	DIMENSION	PRIS/100	FÖRP.
33185040	M4	400,00	100	33185060	M6	800,00	100
33185050	M5	500,00	100	33185080	M8	1 800,00	100

LM6M

Låsmutter, mässing med plastinsats

DIN 985

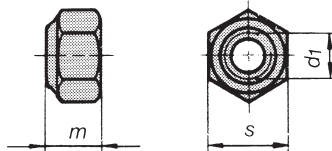

A = Anskaffning
Leveranstiden vid anskaffning
är normalt 1 - 6 veckor

<i>d1</i>	M3	M4	M5	M6	M8
Gängstigning	0,5	0,7	0,8	1	1,25
<i>s</i>	5,5	7	8	10	13
<i>m</i>	4	5	5	6	8

ART.NR.	DIMENSION	PRIS/100	FÖRP.	ART.NR.	DIMENSION	PRIS/100	FÖRP.
33100030	M3	1 500,00	200	33100060	M6	670,00	200
33100040	M4	585,00	200	33100080	M8	1 100,00	200
33100050	M5	646,00	200				

MVM

Vingmutter, mässing

DIN 315

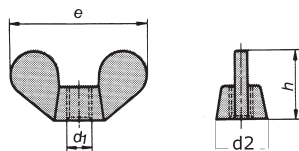

A = Anskaffning
Leveranstiden vid anskaffning
är normalt 1 - 6 veckor

<i>d1</i>	M3	M4	M5	M6	M8	M10	M12
Gängstigning	0,5	0,7	0,8	1	1,25	1,5	1,75
<i>e</i>	20	20	25	32	40	50	64
<i>h</i>	10	10	12	16	20	25	32

ART.NR.	DIMENSION	PRIS/100	FÖRP.	ART.NR.	DIMENSION	PRIS/100	FÖRP.
33200030	M3	A	200	33200080	M8	3 450,00	100
33200040	M4	1 000,00	100	33200100	M10	5 500,00	100
33200050	M5	1 340,00	100	33200120	M12	11 500,00	50
33200060	M6	2 080,00	100				

MILJÖSYSTEM ENLIGT ISO 14000

Vi har utarbetat en miljöplan vad gäller hantering av avfall och annat material som vi använder och lämnar ifrån oss. Våra fabriker har kommit långt i sitt miljöarbete och är idag certifierade enligt ISO 14 000.

ENSAT 309

Insatsgänga, mässing

För trä och mjuk plast

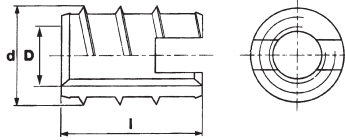

A = Anskaffning
Leveranstiden vid anskaffning
är normalt 1 - 6 veckor

D	M3	M4	M5	M6	M8	M10	M12
Gångstigning innergänga	0,5	0,7	0,8	1	1,25	1,5	1,75
d	5,5	7	9	10	13	16	19
Borrdiameter i mjukt trä	4,2-4,1	5,2-5,1	6,7-6,6	7,7-7,6	10,1-9,9	12,6-12,4	15,6-15,4
Borrdiameter i hårt trä	4,3-4,2	5,3-5,2	6,9-6,7	7,9-7,7	10,3-10,1	12,8-12,6	15,8-15,6

ART.NR.	DIMENSION	PRIS/100	FÖRP.	ART.NR.	DIMENSION	PRIS/100	FÖRP.
33800030	M3X6	626,00	100	33800080	M8X20	2 376,00	100
33800040	M4X10	780,00	100	33800100	M10X23	4 164,00	100
33800050	M5X12	1 003,00	100	33800120	M12X26	6 604,00	100
33800060	M6X14	1 729,00	100				

SPIRO SP

Insatsgänga, mässing

För plast

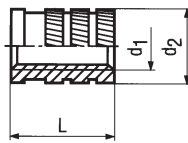

A = Anskaffning
Leveranstiden vid anskaffning
är normalt 1 - 6 veckor

Dimension	M2	M2,5	M3	M4	M5	M6	M8
d2	3,3	4,2	4,2	5,8	6,6	8,2	9,7
L	4,1	5,3	5,3	7,4	8,3	9,2	9,2
Borrdiameter	3,1	3,8	3,8	5,4	6,2	7,8	9,3

ART.NR.	DIMENSION	PRIS/100	FÖRP.	ART.NR.	DIMENSION	PRIS/100	FÖRP.
33700020	M2	478,00	100	33700050	M5	668,00	100
33700025	M2,5	369,00	100	33700060	M6	753,00	100
33700030	M3	380,00	100	33700080	M8	1 011,00	100
33700040	M4	499,00	100				

VÅR HEMSIDA
www.sifvert-skruv.se

På vår hemsida finns aktuell information om vår verksamhet.

Där går också att tanka hem vår katalog
samt skicka förfrågningar och beställningar.

RB

Rund bricka , mässing

DIN 125

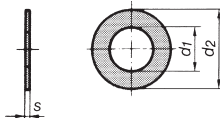

A = Anskaffning
Leveranstiden vid anskaffning
är normalt 1 - 6 veckor

d1	3,2	4,3	5,3	6,4	8,4	10,5	13	17	21
d2	7	9	10	12	16	20	24	30	37
s	0,5	0,8	1	1,6	1,6	2	2,5	3	3
Anpassad för	M3	M4	M5	M6	M8	M10	M12	M16	M20

ART.NR.	DIMENSION	PRIS/100	FÖRP.	ART.NR.	DIMENSION	PRIS/100	FÖRP.
34000030	3,2X7X0,5	29,00	1000	34000100	10,5X20X2	627,00	500
34000040	4,3X9X0,8	57,00	1000	34000120	13X24X2,5	1 155,00	500
34000050	5,3X10X1	94,00	1000	34000160	17X30X3	2 090,00	250
34000060	6,4X12X1,6	165,00	1000	34000200	21X37X3	2 860,00	50
34000080	8,4X16X1,6	319,00	1000				

RBS

Rund bricka med stor ytterdiameter, mässing

DIN 9021

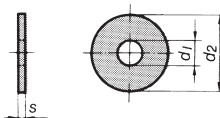

A = Anskaffning
Leveranstiden vid anskaffning
är normalt 1 - 6 veckor

d1	3,2	4,3	5,3	6,4	8,4	10,5	13
d2	9	12	15	18	24	30	37
s	0,8	1	1,2	1,6	2	2,5	3
Anpassad för	M3	M4	M5	M6	M8	M10	M12

ART.NR.	DIMENSION	PRIS/100	FÖRP.	ART.NR.	DIMENSION	PRIS/100	FÖRP.
34070030	3,2X9X0,8	94,00	1000	34070080	8,4X24X2	755,00	500
34070040	4,3X12X1	131,00	1000	34070100	10,5X30X2,5	1 563,00	100
34070050	5,3X15X1,2	221,00	1000	34070120	13X37X3	3 074,00	100
34070060	6,4X18X1,6	312,00	1000				

FRB

Klädselbricka för försänkt skruv,
pressad mässingplåt

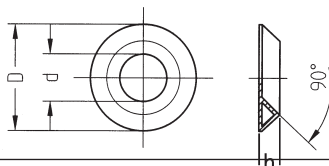

A = Anskaffning
Leveranstiden vid anskaffning
är normalt 1 - 6 veckor

d1	4	5	6	7
d2	9	11	13	15
h	1,8	2,2	2,3	2,5
Anpassad för	M3	M3,5/M4	M4/M5	M5/M6

ART.NR.	DIMENSION	PRIS/100	FÖRP.	ART.NR.	DIMENSION	PRIS/100	FÖRP.
34500030	4X9	182,00	200	34500050	6X13	210,00	200
34500040	5X11	190,00	200	34500060	7X15	220,00	200

FRB FN

Klädselbricka för försänkt skruv,
pressad mässingplåt, förnicklad

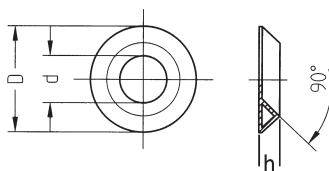

A = Anskaffning
Leveranstiden vid anskaffning
är normalt 1 - 6 veckor

d1	4	5	6	7
d2	9	11	13	15
h	1,8	2,2	2,3	2,5
Anpassad för	M3	M3,5/M4	M4/M5	M5/M6

ART.NR.	DIMENSION	PRIS/100	FÖRP.	ART.NR.	DIMENSION	PRIS/100	FÖRP.
34501030	4X9	282,00	200	34501050	6X13	370,00	200
34501040	5X11	310,00	200	34501060	7X15	580,00	200

TKS

Träskruv med kullrig skalle
och mejselfår, mässing

DIN 96

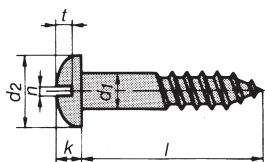

A = Anskaffning
Leveranstiden vid anskaffning
är normalt 1 - 6 veckor

d1	1,6	2	2,5	3	3,5	4	4,5	5	6
d2	3,2	4	5	6	7	8	9	10	12
k	1,1	1,4	1,7	2,1	2,4	2,8	3,1	3,5	4,2
n	0,4	0,5	0,6	0,8	0,8	1	1	1,2	1,6
t	0,7	0,9	1,1	1,35	1,6	1,8	2	2,3	2,7

ART.NR.	DIMENSION	PRIS/100	FÖRP.	ART.NR.	DIMENSION	PRIS/100	FÖRP.
3900016008	1,6X8	212,00	500	3900040025	4X25	300,00	200
3900016010	1,6X10	212,00	500	3900040030	4X30	350,00	200
3900016012	1,6X12	212,00	500	3900040035	4X35	473,00	200
3900016016	1,6X16	257,00	500	3900040040	4X40	525,00	200
3900020008	2X8	216,00	500	3900040045	4X45	605,00	200
3900020010	2X10	216,00	500	3900040050	4X50	588,00	200
3900020012	2X12	216,00	500	3900040060	4X60	1 256,00	200
3900020016	2X16	251,00	500	3900045016	4,5X16	551,00	200
3900020020	2X20	284,00	500	3900045020	4,5X20	540,00	200
3900025008	2,5X8	225,00	500	3900045025	4,5X25	402,00	200
3900025010	2,5X10	203,00	500	3900045030	4,5X30	491,00	200
3900025012	2,5X12	203,00	500	3900045035	4,5X35	516,00	200
3900025016	2,5X16	242,00	500	3900045040	4,5X40	633,00	200
3900025020	2,5X20	275,00	500	3900045045	4,5X45	672,00	200
3900025025	2,5X25	368,00	500	3900045050	4,5X50	845,00	200
3900030008	3X8	225,00	200	3900045060	4,5X60	1 316,00	200
3900030010	3X10	225,00	200	3900050016	5X16	633,00	200
3900030012	3X12	225,00	200	3900050020	5X20	614,00	200
3900030016	3X16	230,00	200	3900050025	5X25	614,00	200
3900030020	3X20	240,00	200	3900050030	5X30	614,00	200
3900030025	3X25	257,00	200	3900050035	5X35	684,00	200
3900030030	3X30	296,00	200	3900050040	5X40	732,00	200
3900030035	3X35	428,00	200	3900050045	5X45	845,00	200
3900030040	3X40	593,00	200	3900050050	5X50	909,00	200
3900035012	3,5X12	270,00	200	3900050060	5X60	1 197,00	200
3900035016	3,5X16	221,00	200	3900050070	5X70	1 272,00	200
3900035020	3,5X20	221,00	200	3900050080	5X80	2 147,00	200
3900035025	3,5X25	266,00	200	3900060030	6X30	1 163,00	200
3900035030	3,5X30	305,00	200	3900060035	6X35	1 193,00	200
3900035035	3,5X35	407,00	200	3900060040	6X40	1 130,00	200
3900035040	3,5X40	456,00	200	3900060045	6X45	1 268,00	200
3900035045	3,5X45	1 011,00	200	3900060050	6X50	1 268,00	200
3900035050	3,5X50	1 113,00	200	3900060060	6X60	1 698,00	100
3900040010	4X10	318,00	200	3900060070	6X70	1 988,00	100
3900040012	4X12	318,00	200	3900060080	6X80	2 307,00	100
3900040016	4X16	266,00	200	3900060100	6X100	3 888,00	100
3900040020	4X20	266,00	200				

TKS FN

Träskruv med kullrig skalle
och mejselfår, mässing, förnicklad

DIN 96

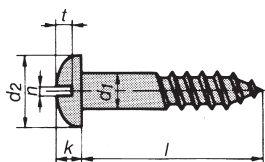

A = Anskaffning
Leveranstiden vid anskaffning
är normalt 1 - 6 veckor

d1	2	2,5	3	3,5	4	5
d2	4	5	6	7	8	10
k	1,4	1,7	2,1	2,4	2,8	3,5
n	0,5	0,6	0,8	0,8	1	1,2
t	0,9	1,1	1,35	1,6	1,8	2,3

ART.NR.	DIMENSION	PRIS/100	FÖRP.	ART.NR.	DIMENSION	PRIS/100	FÖRP.
3900120010	2X10	270,00	500	3900140016	4X16	363,00	200
3900120012	2X12	A	500	3900140020	4X20	380,00	200
3900125012	2,5X12	270,00	500	3900140025	4X25	428,00	200
3900125016	2,5X16	323,00	500	3900140030	4X30	500,00	200
3900130016	3X16	246,00	200	3900140035	4X35	638,00	200
3900130020	3X20	266,00	200	3900140040	4X40	711,00	200
3900130025	3X25	330,00	200	3900150030	5X30	861,00	200
3900135016	3,5X16	291,00	200	3900150040	5X40	1 079,00	200
3900135020	3,5X20	305,00	200	3900150050	5X50	1 268,00	200
3900135025	3,5X25	363,00	200				

TFS

Träskruv med försänkt skalle
och mejselfår, mässing

DIN 97

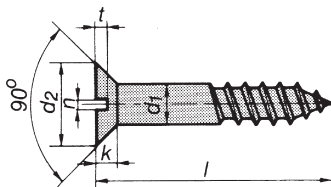

A = Anskaffning
Leveranstiden vid anskaffning
är normalt 1 - 6 veckor

d1	2	2,5	3	3,5	4	4,5	5	6
d2	3,8	4,7	5,6	6,5	7,5	8,3	9,2	11,5
k	1,2	1,5	1,65	1,93	2,2	2,35	2,5	3
n	0,5	0,6	0,8	0,8	1	1	1,2	1,6
t	0,6	0,7	0,85	1	1,1	1,2	1,3	1,6

ART.NR.	DIMENSION	PRIS/100	FÖRP.	ART.NR.	DIMENSION	PRIS/100	FÖRP.
3900520008	2X8	195,00	500	3900535020	3,5X20	186,00	200
3900520010	2X10	195,00	500	3900535025	3,5X25	225,00	200
3900520012	2X12	200,00	500	3900535030	3,5X30	270,00	200
3900520016	2X16	225,00	500	3900535035	3,5X35	309,00	200
3900520020	2X20	236,00	500	3900535040	3,5X40	411,00	200
3900525008	2,5X8	182,00	500	3900535045	3,5X45	495,00	200
3900525010	2,5X10	186,00	500	3900535050	3,5X50	600,00	200
3900525012	2,5X12	186,00	500	3900540010	4X10	354,00	200
3900525016	2,5X16	191,00	500	3900540012	4X12	359,00	200
3900525020	2,5X20	207,00	500	3900540016	4X16	257,00	200
3900525025	2,5X25	279,00	500	3900540020	4X20	260,00	200
3900525030	2,5X30	323,00	500	3900540025	4X25	275,00	200
3900530010	3X10	182,00	200	3900540030	4X30	314,00	200
3900530012	3X12	182,00	200	3900540035	4X35	359,00	200
3900530016	3X16	153,00	200	3900540040	4X40	398,00	200
3900530020	3X20	173,00	200	3900540045	4X45	461,00	200
3900530025	3X25	195,00	200	3900540050	4X50	545,00	200
3900530030	3X30	230,00	200	3900540055	4X55	905,00	200
3900530035	3X35	309,00	200	3900540060	4X60	816,00	200
3900530040	3X40	411,00	200	3900545016	4,5X16	507,00	200
3900530045	3X45	486,00	200	3900545020	4,5X20	368,00	200
3900530050	3X50	593,00	200	3900545025	4,5X25	368,00	200
3900535010	3,5X10	251,00	200	3900545030	4,5X30	452,00	200
3900535012	3,5X12	261,00	200	3900545035	4,5X35	468,00	200
3900535016	3,5X16	168,00	200	3900545040	4,5X40	486,00	200

ART.NR.	DIMENSION	PRIS/100	FÖRP.	ART.NR.	DIMENSION	PRIS/100	FÖRP.
3900545045	4,5X45	549,00	200	3900550090	5X90	2 396,00	200
3900545050	4,5X50	629,00	200	3900550100	5X100	2 489,00	200
3900545060	4,5X60	816,00	200	3900560020	6X20	1 179,00	200
3900545070	4,5X70	1 763,00	200	3900560025	6X25	1 145,00	200
3900550020	5X20	555,00	200	3900560030	6X30	1 163,00	200
3900550025	5X25	561,00	200	3900560035	6X35	1 184,00	200
3900550030	5X30	561,00	200	3900560040	6X40	1 190,00	200
3900550035	5X35	618,00	200	3900560045	6X45	1 195,00	200
3900550040	5X40	654,00	200	3900560050	6X50	1 200,00	200
3900550045	5X45	672,00	200	3900560060	6X60	1 281,00	100
3900550050	5X50	741,00	200	3900560070	6X70	1 763,00	100
3900550055	5X55	954,00	200	3900560080	6X80	1 988,00	100
3900550060	5X60	888,00	200	3900560090	6X90	2 190,00	100
3900550070	5X70	1 130,00	200	3900560100	6X100	2 190,00	100
3900550080	5X80	1 763,00	200				

TFS FN

Träskruv med försänkt skalle
och mejselfår, mässing, förnicklad
DIN 97

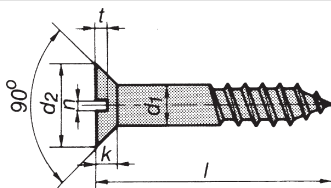

A = Anskaffning
Leveranstiden vid anskaffning
är normalt 1 - 6 veckor

d1	2	2,5	3	3,5	4	4,5	5
d2	3,8	4,7	5,6	6,5	7,5	8,3	9,2
k	1,2	1,5	1,65	1,93	2,2	2,35	2,5
n	0,5	0,6	0,8	0,8	1	1	1,2
t	0,6	0,7	0,85	1	1,1	1,2	1,3

ART.NR.	DIMENSION	PRIS/100	FÖRP.	ART.NR.	DIMENSION	PRIS/100	FÖRP.
3900620010	2X10	A	500	3900635025	3,5X25	279,00	200
3900620012	2X12	A	500	3900635030	3,5X30	330,00	200
3900620016	2X16	A	500	3900640020	4X20	300,00	200
3900620020	2X20	A	500	3900640025	4X25	350,00	200
3900625012	2,5X12	242,00	500	3900640030	4X30	402,00	200
3900625016	2,5X16	251,00	500	3900640035	4X35	456,00	200
3900625020	2,5X20	279,00	500	3900640040	4X40	507,00	200
3900630012	3X12	216,00	200	3900640050	4X50	681,00	200
3900630016	3X16	191,00	200	3900645030	4,5X30	A	200
3900630020	3X20	212,00	200	3900645040	4,5X40	618,00	200
3900630025	3X25	242,00	200	3900645050	4,5X50	A	200
3900630030	3X30	314,00	200	3900650030	5X30	698,00	200
3900635016	3,5X16	203,00	200	3900650040	5X40	821,00	200
3900635020	3,5X20	230,00	200	3900650050	5X50	947,00	200

BUTIK FÖR PRIVATPERSONER OCH SMÅFÖRETAG

På gatuplanet på Lindhagensgatan 53 finns vår butik.
Privatpersoner eller företag med mindre inköpsbehov
är välkomna in att handla på vanligt butiksvi.
Det är öppet alla vardagar mellan kl 08.00 och 17.00.

TKFS

Träskruv med kullerförsänkt skalle
och mejselfår, mässing

DIN 95

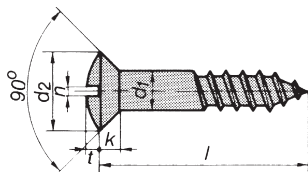

A = Anskaffning
Leveranstiden vid anskaffning
är normalt 1 - 6 veckor

	1,6	2	2,5	3	3,5	4	4,5	5	6
d1	1,6	2	2,5	3	3,5	4	4,5	5	6
d2	3	3,8	4,7	5,6	6,5	7,5	8,3	9,2	11
k	0,96	1,2	1,5	1,65	1,93	2,2	2,35	2,5	3
n	0,4	0,5	0,6	0,8	0,8	1	1	1,2	1,6
t	0,8	1	1,2	1,45	1,7	1,9	2,1	2,3	2,8

ART.NR.	DIMENSION	PRIS/100	FÖRP.	ART.NR.	DIMENSION	PRIS/100	FÖRP.
3901016010	1,6X10	195,00	500	3901040050	4X50	545,00	200
3901016012	1,6X12	195,00	500	3901040055	4X55	905,00	200
3901020008	2X8	198,00	500	3901040060	4X60	816,00	200
3901020010	2X10	195,00	500	3901045016	4,5X16	507,00	200
3901020012	2X12	191,00	500	3901045020	4,5X20	368,00	200
3901020016	2X16	225,00	500	3901045025	4,5X25	368,00	200
3901020020	2X20	236,00	500	3901045030	4,5X30	452,00	200
3901025010	2,5X10	186,00	500	3901045035	4,5X35	468,00	200
3901025013	2,5X12	186,00	500	3901045040	4,5X40	486,00	200
3901025016	2,5X16	191,00	500	3901045045	4,5X45	549,00	200
3901025020	2,5X20	207,00	500	3901045050	4,5X50	629,00	200
3901025025	2,5X25	279,00	500	3901045060	4,5X60	816,00	200
3901030010	3X10	182,00	200	3901045070	4,5X70	1 763,00	200
3901030013	3X12	182,00	200	3901050016	5X16	777,00	200
3901030016	3X16	153,00	200	3901050020	5X20	555,00	200
3901030020	3X20	173,00	200	3901050025	5X25	561,00	200
3901030025	3X25	195,00	200	3901050030	5X30	561,00	200
3901030030	3X30	230,00	200	3901050035	5X35	618,00	200
3901030035	3X35	309,00	200	3901050040	5X40	654,00	200
3901030040	3X40	411,00	200	3901050045	5X45	672,00	200
3901035010	3,5X10	270,00	200	3901050050	5X50	741,00	200
3901035013	3,5X12	261,00	200	3901050055	5X55	981,00	200
3901035016	3,5X16	168,00	200	3901050060	5X60	888,00	200
3901035020	3,5X20	186,00	200	3901050070	5X70	1 130,00	200
3901035025	3,5X25	225,00	200	3901050080	5X80	1 763,00	200
3901035030	3,5X30	270,00	200	3901050090	5X90	2 396,00	200
3901035035	3,5X35	309,00	200	3901050100	5X100	2 489,00	200
3901035040	3,5X40	411,00	200	3901060020	6X20	1 179,00	200
3901035045	3,5X45	495,00	200	3901060025	6X25	1 179,00	200
3901035050	3,5X50	600,00	200	3901060030	6X30	1 163,00	200
3901040013	4X12	354,00	200	3901060035	6X35	1 184,00	200
3901040016	4X16	257,00	200	3901060040	6X40	1 170,00	200
3901040020	4X20	246,00	200	3901060050	6X50	1 180,00	200
3901040025	4X25	275,00	200	3901060060	6X60	1 281,00	100
3901040030	4X30	314,00	200	3901060070	6X70	1 763,00	100
3901040035	4X35	354,00	200	3901060080	6X80	1 988,00	100
3901040040	4X40	398,00	200	3901060090	6X90	2 190,00	100
3901040045	4X45	461,00	200	3901060100	6X100	2 190,00	100

TKFS FN

Träskruv med kullerförsänkt skalle
och mejselfår, mässing, förnicklat

DIN 95

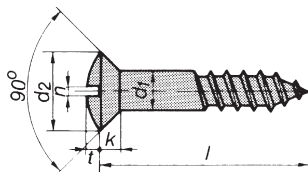

A = Anskaffning
Leveranstiden vid anskaffning
är normalt 1 - 6 veckor

	1,6	2	2,5	3	3,5	4	4,5	5	6
d1	1,6	2	2,5	3	3,5	4	4,5	5	6
d2	3	3,8	4,7	5,6	6,5	7,5	8,3	9,2	11
k	0,96	1,2	1,5	1,65	1,93	2,2	2,35	2,5	3
n	0,4	0,5	0,6	0,8	0,8	1	1	1,2	1,6
t	0,8	1	1,2	1,45	1,7	1,9	2,1	2,3	2,8

ART.NR.	DIMENSION	PRIS/100	FÖRP.	ART.NR.	DIMENSION	PRIS/100	FÖRP.
3901116010	1,6X10	236,00	500	3901140040	4X40	486,00	200
3901116012	1,6X12	236,00	500	3901140045	4X45	555,00	200
3901120010	2X10	225,00	500	3901140050	4X50	654,00	200
3901120012	2X12	240,00	500	3901140060	4X60	959,00	200
3901120016	2X16	270,00	500	3901140070	4X70	1 742,00	200
3901125010	2,5X10	236,00	500	3901145020	4,5X20	428,00	200
3901125013	2,5X12	230,00	500	3901145025	4,5X25	437,00	200
3901125016	2,5X16	240,00	500	3901145030	4,5X30	540,00	200
3901125020	2,5X20	270,00	500	3901145035	4,5X35	566,00	200
3901125025	2,5X25	330,00	500	3901145040	4,5X40	593,00	200
3901130010	3X10	212,00	200	3901145045	4,5X45	672,00	200
3901130013	3X12	216,00	200	3901145050	4,5X50	765,00	200
3901130016	3X16	191,00	200	3901145060	4,5X60	986,00	200
3901130020	3X20	212,00	200	3901150020	5X20	633,00	200
3901130025	3X25	246,00	200	3901150025	5X25	654,00	200
3901130030	3X30	314,00	200	3901150030	5X30	654,00	200
3901130035	3X35	380,00	200	3901150035	5X35	741,00	200
3901130040	3X40	495,00	200	3901150040	5X40	786,00	200
3901135013	3,5X12	296,00	200	3901150045	5X45	816,00	200
3901135016	3,5X16	207,00	200	3901150050	5X50	905,00	200
3901135020	3,5X20	230,00	200	3901150060	5X60	1 086,00	200
3901135025	3,5X25	330,00	200	3901150070	5X70	1 379,00	200
3901135030	3,5X30	330,00	200	3901150080	5X80	2 396,00	200
3901135035	3,5X35	384,00	200	3901160040	6X40	1 340,00	200
3901135040	3,5X40	500,00	200	3901160050	6X50	1 400,00	200
3901140013	4X12	402,00	200	3901160060	6X60	1 581,00	100
3901140016	4X16	296,00	200	3901160070	6X70	2 102,00	100
3901140020	4X20	300,00	200	3901160080	6X80	2 465,00	100
3901140025	4X25	335,00	200	3901160090	6X90	2 621,00	100
3901140030	4X30	384,00	200	3901160100	6X100	2 669,00	100
3901140035	4X35	432,00	200				

KUNDANPASSAD LAGERHÅLLNING

av såväl standard som specialartiklar ger
leveranssäkerhet och korta ledtider till kunden.

M6SH

Sexkantskruv, aluminium
DIN 933 (ISO 4014/4017)

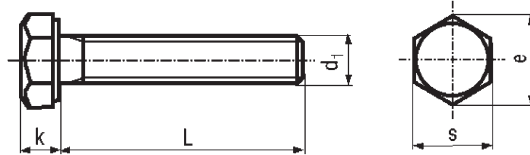

H = Helgängad
A = Anskaffning
Leveranstiden vid anskaffning
är normalt 1 - 6 veckor

d	M6	M8	M10
Gängstigning	1	1,25	1,5
k	4	5,3	6,4
s	10	13	17(16)

ART.NR.	DIMENSION	PRIS/100	FÖRP.	ART.NR.	DIMENSION	PRIS/100	FÖRP.
4111006016	M6X16 H	700,00	100	4111008025	M8X25 H	2 600,00	100
4111006020	M6X20 H	700,00	100	4111008030	M8X30 H	2 800,00	100
4111006025	M6X25 H	1 300,00	100	4111008040	M8X40 H	3 400,00	100
4111006030	M6X30 H	1 400,00	100	4111008050	M8X50 H	3 400,00	100
4111006040	M6X40 H	1 400,00	100	4111010025	M10X25 H	3 500,00	100
4111006050	M6X50 H	2 400,00	100	4111010030	M10X30 H	4 600,00	100
4111008016	M8X16 H	1 800,00	100	4111010040	M10X40 H	4 600,00	100
4111008020	M8X20 H	2 700,00	100	4111010050	M10X50 H	4 600,00	100

M6M

Sexkantsmutter, aluminium
DIN 934 (ISO 4032)

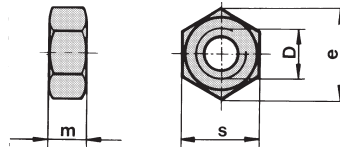

A = Anskaffning
Leveranstiden vid anskaffning
är normalt 1 - 6 veckor

d1	M3	M4	M5	M6	M8	M10	M12	M16
Gängstigning	0,5	0,7	0,8	1	1,25	1,5	1,75	2
s	5,5	7	8	10	13	17 (16)	19 (18)	24
m	2,4	3,2	4	5	6,5	8 (8,4)	10 (10,8)	3

ART.NR.	DIMENSION	PRIS/100	FÖRP.	ART.NR.	DIMENSION	PRIS/100	FÖRP.
43010030	M3	1 000,00	100	43010080	M8	840,00	100
43010040	M4	560,00	100	43010100	M10	2 240,00	100
43010050	M5	560,00	100	43010120	M12	A	100
43010060	M6	600,00	100	43010160	M16	A	100

RB

Rund bricka, aluminium
DIN 125

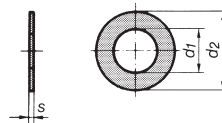

A = Anskaffning
Leveranstiden vid anskaffning
är normalt 1 - 6 veckor

d1	3,2	4,3	5,3	6,4	8,4	10,5	13	17
d2	7	9	10	12	16	20	24	30
s	0,5	0,8	1	1,6	1,6	2	2,5	3
Anpassad för	M3	M4	M5	M6	M8	M10	M12	M16

ART.NR.	DIMENSION	PRIS/100	FÖRP.	ART.NR.	DIMENSION	PRIS/100	FÖRP.
44000030	3,2X7X0,5	30,00	200	44000080	8,4X16X1,6	247,00	100
44000040	4,3X9X0,8	47,00	200	44000100	10,5X20X2	404,00	100
44000050	5,3X10X1	59,00	200	44000120	13X24X2,5	696,00	100
44000060	6,4X12X1,6	135,00	100	44000160	17X30X3	1 300,00	100

MCS

Maskinskruv med cylindrisk skalle
och mejselspår, polyamid
DIN 84 (≈ISO 1207)

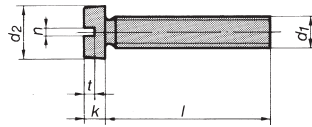

H = Helgängad
A = Anskaffning
Leveranstiden vid anskaffning
är normalt 1 - 6 veckor

	M3	M4	M5	M6	M8
d1 Gångstigning	0,5	0,7	0,8	1	1,25
d2	5,5	7	8,5	10	13
k	2	2,6	3,3	3,9	5
n	0,8	1,2	1,2	1,6	2
t	0,85	1,1	1,3	1,6	2

ART.NR.	DIMENSION	PRIS/100	FÖRP.	ART.NR.	DIMENSION	PRIS/100	FÖRP.
5700003004	M3X4 H	132,00	200	5700005020	M5X20 H	237,00	200
5700003006	M3X6 H	128,00	200	5700005025	M5X25 H	353,00	200
5700003008	M3X8 H	132,00	200	5700005030	M5X30 H	401,00	200
5700003010	M3X10 H	149,00	200	5700005035	M5X35 H	471,00	200
5700003012	M3X12 H	168,00	200	5700005040	M5X40 H	475,00	200
5700003016	M3X16 H	170,00	200	5700005050	M5X50 H	475,00	200
5700003020	M3X20 H	175,00	200	5700006008	M6X8 H	257,00	200
5700003025	M3X25 H	209,00	200	5700006010	M6X10 H	255,00	200
5700003030	M3X30 H	216,00	200	5700006012	M6X12 H	231,00	200
5700004006	M4X6 H	132,00	200	5700006016	M6X16 H	279,00	200
5700004008	M4X8 H	153,00	200	5700006020	M6X20 H	291,00	200
5700004010	M4X10 H	153,00	200	5700006025	M6X25 H	363,00	200
5700004012	M4X12 H	224,00	200	5700006030	M6X30 H	365,00	200
5700004016	M4X16 H	176,00	200	5700006035	M6X35 H	365,00	200
5700004020	M4X20 H	177,00	200	5700006040	M6X40 H	365,00	200
5700004025	M4X25 H	245,00	200	5700006045	M6X45 H	441,00	200
5700004030	M4X30 H	245,00	200	5700006050	M6X50 H	497,00	200
5700004035	M4X35 H	250,00	200	5700006060	M6X60 H	500,00	200
5700004040	M4X40 H	250,00	200	5700008016	M8X16 H	557,00	200
5700005006	M5X6 H	216,00	200	5700008020	M8X20 H	560,00	200
5700005008	M5X8 H	219,00	200	5700008025	M8X25 H	657,00	200
5700005010	M5X10 H	228,00	200	5700008030	M8X30 H	660,00	200
5700005012	M5X12 H	230,00	200	5700008040	M8X40 H	711,00	200
5700005016	M5X16 H	237,00	200	5700008050	M8X50 H	855,00	200

MFS

Maskinskruv med försänkt skalle
och mejselspår, polyamid
DIN 963 (≈ISO 2009)

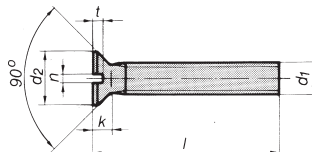

H = Helgängad
A = Anskaffning
Leveranstiden vid anskaffning
är normalt 1 - 6 veckor

	M3	M4	M5	M6	M8
d1 Gångstigning	0,5	0,7	0,8	1	1,25
d2	5,6	7,5	9,2	11	14,5
k	1,65	2,2	2,5	3	4
n	0,8	1	1,2	1,6	2
t	0,6	0,8	1	1,2	1,6

ART.NR.	DIMENSION	PRIS/100	FÖRP.	ART.NR.	DIMENSION	PRIS/100	FÖRP.
5701003006	M3X6 H	272,00	200	5701004020	M4X20 H	371,00	200
5701003008	M3X8 H	282,00	200	5701004025	M4X25 H	386,00	200
5701003010	M3X10 H	293,00	200	5701004030	M4X30 H	407,00	200
5701003012	M3X12 H	297,00	200	5701005010	M5X10 H	362,00	200
5701003016	M3X16 H	302,00	200	5701005016	M5X16 H	420,00	200
5701003020	M3X20 H	317,00	200	5701005020	M5X20 H	465,00	200
5701004010	M4X10 H	336,00	200	5701005025	M5X25 H	495,00	200
5701004012	M4X12 H	351,00	200	5701006010	M6X10 H	407,00	200
5701004016	M4X16 H	357,00	200	5701006012	M6X12 H	446,00	200

ART.NR.	DIMENSION	PRIS/100	FÖRP.	ART.NR.	DIMENSION	PRIS/100	FÖRP.
5701006016	M6X16 H	470,00	200	5701008020	M8X20 H	915,00	200
5701006020	M6X20 H	519,00	200	5701008025	M8X25 H	1 020,00	200
5701006025	M6X25 H	594,00	200	5701008030	M8X30 H	1 163,00	200
5701006030	M6X30 H	644,00	200	5701008040	M8X40 H	1 361,00	200
5701008016	M8X16 H	861,00	200				

MKFS

Maskinskruv med kullerförsänkt skalle
och mejselspår, polyamid

DIN 964 (≈ISO 2010)

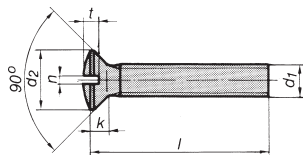

H = Helgängad
A = Anskaffning
Leveranstiden vid anskaffning
är normalt 1 - 6 veckor

d1	M3	M4	M5	M6
Gängstigning	0,5	0,7	0,8	1
d2	5,6	7,5	9,2	11
k	1,65	2,2	2,5	3
n	0,8	1	1,2	1,6
t	1,2	1,6	2	2,4

ART.NR.	DIMENSION	PRIS/100	FÖRP.	ART.NR.	DIMENSION	PRIS/100	FÖRP.
5702003006	M3X6 H	A	100	5702005010	M5X10 H	A	100
5702003008	M3X8 H	A	100	5702005012	M5X12 H	A	100
5702003010	M3X10 H	A	100	5702005016	M5X16 H	A	100
5702003012	M3X12 H	A	100	5702005020	M5X20 H	A	100
5702003016	M3X16 H	A	100	5702005025	M5X25 H	A	100
5702004010	M4X10 H	A	100	5702006010	M6X10 H	A	100
5702004012	M4X12 H	A	100	5702006016	M6X16 H	A	100
5702004016	M4X16 H	A	100	5702006020	M6X20 H	A	100
5702004020	M4X20 H	A	100	5702006025	M6X25 H	A	100
5702004025	M4X25 H	A	100				

MHGS

Helgängad stång, polyamid

DIN 976

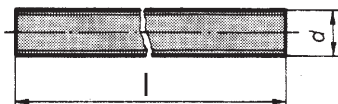

H = Helgängad
A = Anskaffning
Leveranstiden vid anskaffning
är normalt 1 - 6 veckor

d1	M3	M4	M5	M6	M8	M10	M12	M16	M20
Gängstigning	0,5	0,7	0,8	1	1,25	1,5	1,75	2	2,5

ART.NR.	DIMENSION	PRIS/100	FÖRP.	ART.NR.	DIMENSION	PRIS/100	FÖRP.
56050031000	M3X1000	41 000,00	1	56050101000	M10X1000	21 000,00	1
56050041000	M4X1000	23 600,00	1	56050121000	M12X1000	26 000,00	1
56050051000	M5X1000	16 500,00	1	56050161000	M16X1000	30 400,00	1
56050061000	M6X1000	16 500,00	1	56050201000	M20X1000	65 000,00	1
56050081000	M8X1000	17 000,00	1				

M6M

Sexkantmutter, polyamid

DIN 555

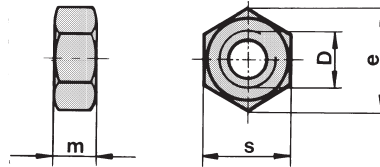

A = Anskaffning
Leveranstiden vid anskaffning
är normalt 1 - 6 veckor

d1	M3	M4	M5	M6	M8	M10	M12	M16	M20
Gångstigning	0,5	0,7	0,8	1	1,25	1,5	1,75	2	2,5
s	5,5	7	8	10	13	17	19	24	30
m	2,4	3,2	4,4	4,6	6,4	9,5	10,4	14,1	16,9

ART.NR.	DIMENSION	PRIS/100	FÖRP.	ART.NR.	DIMENSION	PRIS/100	FÖRP.
53010030	M3	150,00	200	53010100	M10	450,00	100
53010040	M4	160,00	200	53010120	M12	540,00	100
53010050	M5	165,00	200	53010160	M16	1 000,00	100
53010060	M6	180,00	100	53010200	M20	4 300,00	100
53010080	M8	260,00	100				

RB

Rund bricka, polyamid

DIN 125

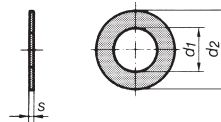

A = Anskaffning
Leveranstiden vid anskaffning
är normalt 1 - 6 veckor

d1	3,2	4,3	5,3	6,4	8,4	10,5	13	17	21
d2	7	9	10	12	16	20	24	30	37
s	0,5	0,8	1	1,6	1,6	2	2,5	3	3
Anpassad för	M3	M4	M5	M6	M8	M10	M12	M16	M20

ART.NR.	DIMENSION	PRIS/100	FÖRP.	ART.NR.	DIMENSION	PRIS/100	FÖRP.
54000030	3,2X7X0,5	28,00	200	54000100	10,5X20X2	166,00	200
54000040	4,3X9X0,8	60,00	200	54000120	13X24X2,5	218,00	100
54000050	5,3X10X1	90,00	200	54000160	17X30X3	430,00	100
54000060	6,4X12X1,6	95,00	200	54000200	21X37X3	690,00	100
54000080	8,4X16X1,6	100,00	200				

RBS

Rund bricka med stor ytterdiameter, polyamid

DIN 9021

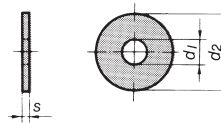

A = Anskaffning
Leveranstiden vid anskaffning
är normalt 1 - 6 veckor

d1	3,2	4,3	5,3	6,4	8,4	10,5	13
d2	9	12	15	18	24	30	37
s	0,8	1	1,2	1,6	2	2,5	3
Anpassad för	M3	M4	M5	M6	M8	M10	M12

ART.NR.	DIMENSION	PRIS/100	FÖRP.	ART.NR.	DIMENSION	PRIS/100	FÖRP.
54071030	3,2X9X0,8	200,00	100	54071080	8,4X24X2	310,00	100
54071040	4,3X12X1	130,00	100	54071100	10,5X30X2,5	340,00	100
54071050	5,3X15X1,2	150,00	100	54071120	13X37X3	500,00	100
54071060	6,4X18X1,6	150,00	100				